

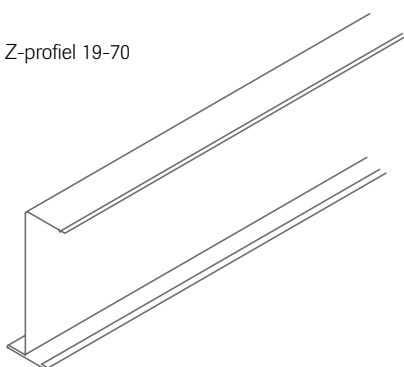

## Z-profielen

## Overzicht overspanningen z-profielen

Z-profiel 19-70



Z-profiel 20, 22, 69

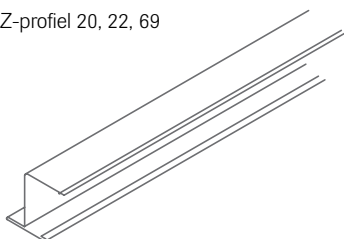

Z-profiel 19-45

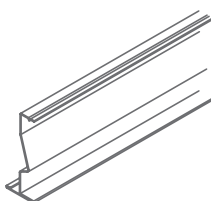

Order nr.	Stok Hoogte (mm)	Materiaal dikte (mm)	> 312,5 mm		> 400 mm	
			15 mm	20 mm	15 mm	20 mm
69	45	0,5	2290	2160	2170	2040
19	70	0,5	2500	2500	2500	2500
19/10	70	0,6	2500	2500	2500	2500
19/45	45	0,6	2310	2180	2190	2070

## Eén systeem, ontelbare mogelijkheden

Het bandrastersysteem van OWAconstruct dankt zijn flexibiliteit aan het uitgebreide assortiment toebehoren. Passend tot op de milimeter nauwkeurig, duurzaam dankzij de onmiskenbare kwaliteit die u van OWA mag verwachten.



Lengtekoppeling



Nonius bovendeel



Nonius onderstuk bandr.



Nonius Borgveer



Wandanker



Haakse verbinder



Z-profiel 19-70



Overzicht bandraster opbouw

## Dimensies per profiel

Type	Omschrijving	Lengte (mm)	Hoogte (mm)	Stuks per pak	Gewicht per pak (kg)	Totale lengte per pak (m)
Z-profiel 19-70	verzinkt	tot 2500	70	25	Afhankelijk van de lengte. Op maat leverbaar	Afhankelijk van de lengte. Op maat leverbaar
Z-profiel 19-45	verzinkt	1800	45	25		
Z-profiel 69	verzinkt	tot 3000	45	25		
Z-profiel 22	verzinkt	tot 3000	33	25		
Z-profiel 20	verzinkt	tot 3000	21	25		



Rechte hoeklijnen

Nr. 50G

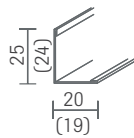

Dikte: 0,5 mm

Nr. 50/14

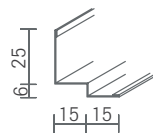

Dikte: 0,5 mm

Nr. 50/15G

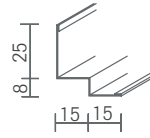

Dikte: 0,5 mm

Nr. 50/19

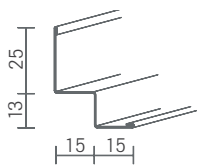

Dikte: 0,5 mm

Nr. 50/22

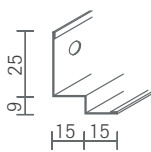

Dikte: 0,5 mm  
Gesleufd

Nr. 51/1

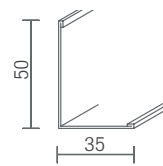

Dikte: 1 mm

Nr. 51/2

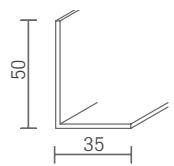

Dikte: 2 mm

Nr. 51/08

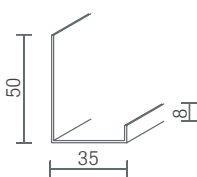

Dikte: 1 mm

Nr. 51/20

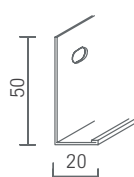

Dikte: 1 mm  
Gesleufd

Nr. 51/22

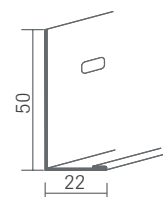

Dikte: 0,7 mm

Nr. 51/24G

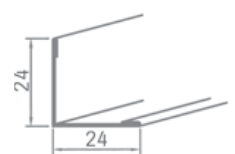

Dikte: 0,5 mm

Nr. 51/25

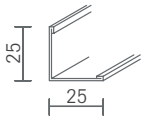

Dikte: 1,0 mm

Nr. 51/32G

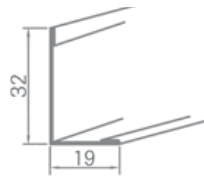

Dikte: 0,5 mm

Nr. 53

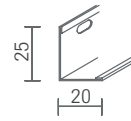

Dikte: 0,6 mm  
Gesleuwd

Nr. 56

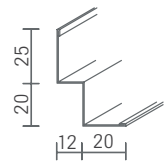

Dikte: 0,6 mm

Nr. 56/22

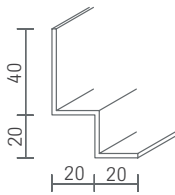

Dikte: 2,0 mm

Nr. 56/20-21-23-35

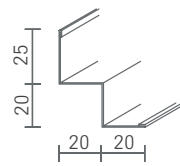

Nr. 56/20 dikte: 0,6 mm  
Nr. 56/21 dikte: 1,0 mm  
Nr. 56/23 dikte: 1,5 mm  
Nr. 56/35 dikte: 0,6 mm  
(met ventilatie sleuven)

Nr. 57

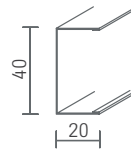

Dikte: 0,5 mm

Nr. 57/10

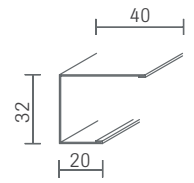

Dikte: 0,6 mm

Nr. 8030/13

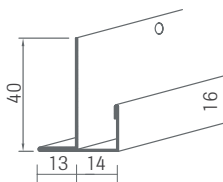

Dikte: 0,5 mm  
(voor 13 mm tegels)

Nr. 8030/15

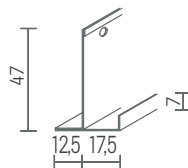

Dikte: 0,6 mm  
(voor 15 mm tegels)

Nr. 8034



Kolom ring, twee delen, natuurlijk aluminium, andere kleuren op aanvraag.  
Diameter 200 - 1000 mm in 50 mm stappen;  
Hoogte 20 mm, breedte 20 mm, dikte 1,5 mm  
Opmerking: max. tolerantie kolom diameter +/- 3 mm;  
ring in het project aanpassen

## Gebogen hoeklijnen

Nr. 50 G

Wandprofiel

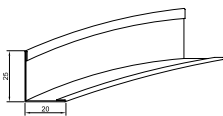

Afmeting: 25/20 mm  
Dikte: 1 mm  
Zichtzijde: wit

Nr. 51/20

Wandprofiel

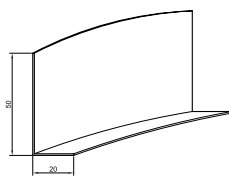

Afmeting: 50/20 mm  
Dikte: 1 mm  
Zichtzijde: wit

Nr. 50/15 G

Contura wandprofiel

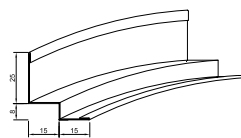

Afmeting: 25/15/8/15 mm  
Dikte: 1 mm  
Zichtzijde: wit

Nr. 56/20

Stufen wandprofiel

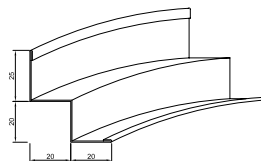

Afmeting: 20/20/20/20 mm  
Dikte: 1 mm  
Zichtzijde: wit

Nr. 57

Wandprofiel

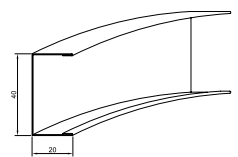

Afmeting: 20/40/20 mm  
Dikte: 1 mm  
Zichtzijde: wit