

Details

Bandraster BR100S



Maatvoering

Bandraster gesleufd BR100S

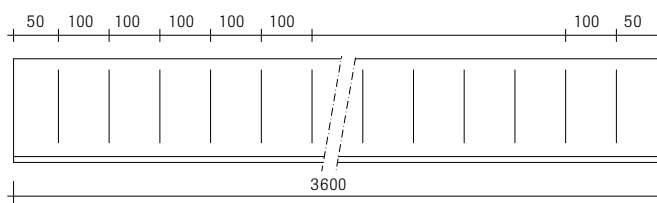

Bandraster ongesleufd BR100

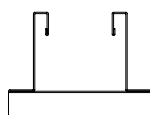
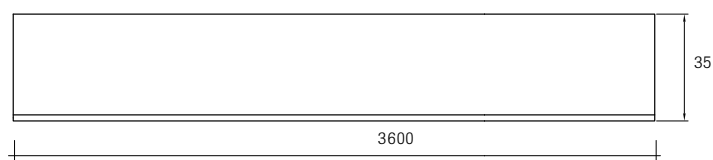

50 mm breed

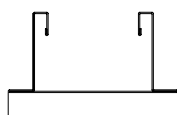

75 mm breed



100 mm breed



125 mm breed



150 mm breed

Voor ruimtelijke flexibiliteit

Het OWAconstruct bandrastersysteem is al voor veel afbouwers de standaard als het gaat om flexibele inrichtingen. Het is zowel geschikt om karakteristieke systeemplafonds mee te realiseren, als om scheidingswanden of andere interieuronderdelen aan te bevestigen.

De bandrasterprofielen zijn verkrijgbaar in vijf verschillende breedtematen. Voor optimale vrijheid in design en toepassing kunnen wij de OWAline profielen leveren in iedere gewenste kleur en lengtemaat. Op de volgende pagina vindt u een overzicht van alle toebehoren.



Toepasbaarheid

Type profiel	S18
Bandraster	•

Te combineren met o.a.: Brillianto A95, Sinfonia

Bijzonderheden

- Elektrolytisch verzinkt bandstaal voorzien van een witte laklaag
- Gesleufd en ongesleufd
- Standaard verkrijgbaar met witte zichtzijde, maar in iedere kleur leverbaar (alle RAL, Sikkens en NCS kleuren) 
- Verkrijgbaar in breedte 50, 75, 100, 125 en 150 mm
- Profielen zijn ook in afwijkende lengtes verkrijgbaar.

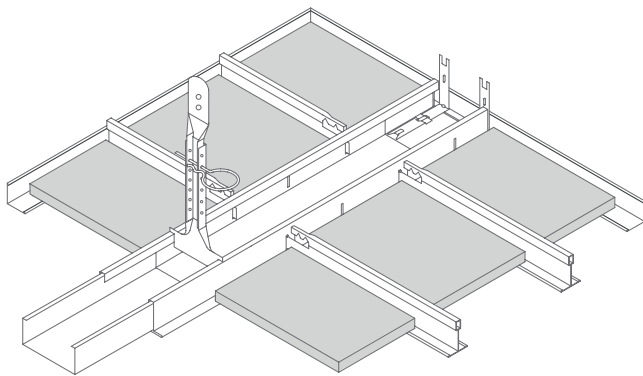

Systeem S18

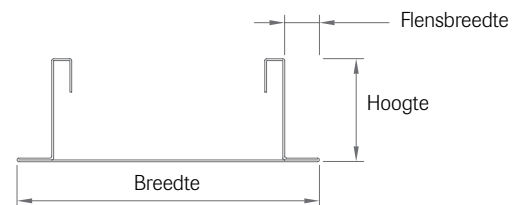

Order nr.	Breedte (mm)	Hoogte (mm)	Flensbreedte (mm)	Dikte (mm)
80/50	50	35	11.5	0.6
80/75	75	35	11.5	0.6
80/100	100	35	11.5	0.6
80/125	125	35	11.5	0.7
80/150	150	35	11.5	0.7
8025/100	100	35	25	0.6

Dimensies per profiel

Type	Omschrijving	Lengte (mm)	Hoogte (mm)	Stuks per pak	Gewicht per pak (kg)	Totale lengte per pak (m)
BR100 3600	Bandraster 100 mm	3600	35	8	30	28,8
BR100S 3600	Bandraster met sleuf 100 mm	3600	35	8	30	28,8



Z-profielen

Overzicht overspanningen z-profielen

Z-profiel 19-70

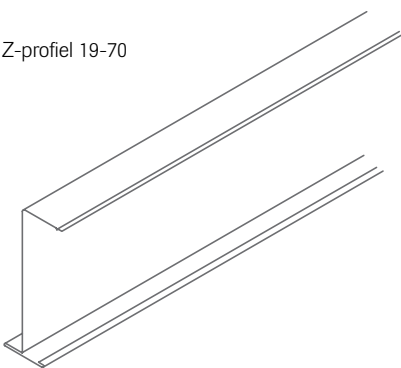

Z-profiel 20, 22, 69

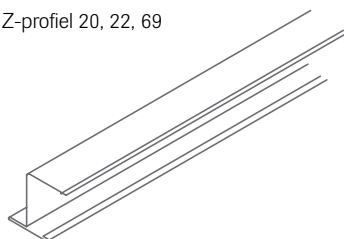

Z-profiel 19-45

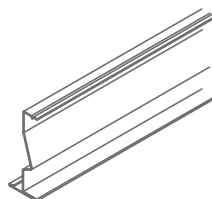

Order nr.	Stok Hoogte (mm)	Materiaal dikte (mm)	> 312,5 mm		> 400 mm	
			15 mm	20 mm	15 mm	20 mm
69	45	0,5	2290	2160	2170	2040
19	70	0,5	2500	2500	2500	2500
19/10	70	0,6	2500	2500	2500	2500
19/45	45	0,6	2310	2180	2190	2070

Eén systeem, ontelbare mogelijkheden

Het bandrastersysteem van OWAconstruct dankt zijn flexibiliteit aan het uitgebreide assortiment toebehoren. Passend tot op de milimeter nauwkeurig, duurzaam dankzij de onmiskenbare kwaliteit die u van OWA mag verwachten.



Lengtekoppeling



Nonius bovendeel



Nonius onderstuk bandr.

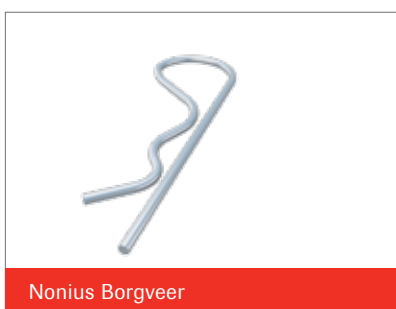

Nonius Borgveer



Wandanker



Haakse verbinder



Z-profiel 19-70



Overzicht bandraster opbouw

Dimensies per profiel

Type	Omschrijving	Lengte (mm)	Hoogte (mm)	Stuks per pak	Gewicht per pak (kg)	Totale lengte per pak (m)
Z-profiel 19-70	verzinkt	tot 2500	70	25	Afhankelijk van de lengte. Op maat leverbaar	Afhankelijk van de lengte. Op maat leverbaar
Z-profiel 19-45	verzinkt	1800	45	25		
Z-profiel 69	verzinkt	tot 3000	45	25		
Z-profiel 22	verzinkt	tot 3000	33	25		
Z-profiel 20	verzinkt	tot 3000	21	25		



Rechte hoeklijnen

Nr. 50G

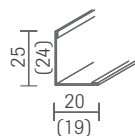

Dikte: 0,5 mm

Nr. 50/14

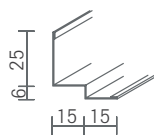

Dikte: 0,5 mm

Nr. 50/15G

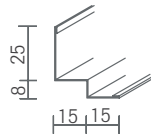

Dikte: 0,5 mm

Nr. 50/19

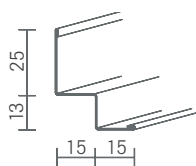

Dikte: 0,5 mm

Nr. 50/22

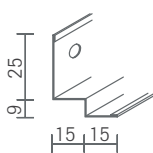

Dikte: 0,5 mm
Gesleufd

Nr. 51/1

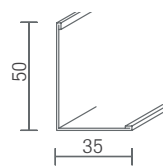

Dikte: 1 mm

Nr. 51/2

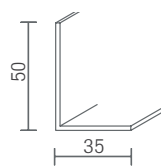

Dikte: 2 mm

Nr. 51/08

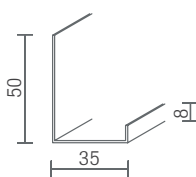

Dikte: 1 mm

Nr. 51/20

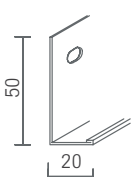

Dikte: 1 mm
Gesleufd

Nr. 51/22

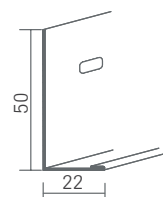

Dikte: 0,7 mm

Nr. 51/24G

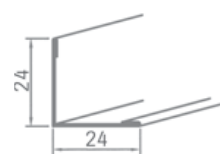

Dikte: 0,5 mm

Nr. 51/25

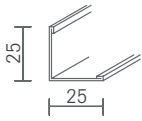

Dikte: 1,0 mm

Nr. 51/32G

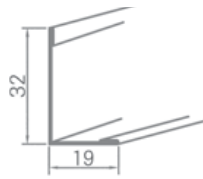

Dikte: 0,5 mm

Nr. 53

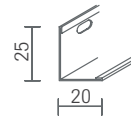

Dikte: 0,6 mm
Gesleuwd

Nr. 56

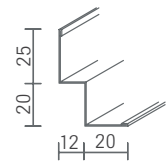

Dikte: 0,6 mm

Nr. 56/22

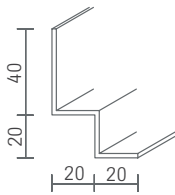

Dikte: 2,0 mm

Nr. 56/20-21-23-35

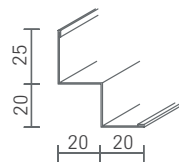

Nr. 56/20 dikte: 0,6 mm
Nr. 56/21 dikte: 1,0 mm
Nr. 56/23 dikte: 1,5 mm
Nr. 56/35 dikte: 0,6 mm
(met ventilatie sleuven)

Nr. 57

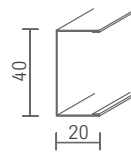

Dikte: 0,5 mm

Nr. 57/10

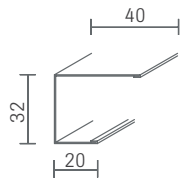

Dikte: 0,6 mm

Nr. 8030/13

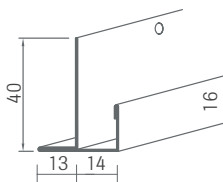

Dikte: 0,5 mm
(voor 13 mm tegels)

Nr. 8030/15

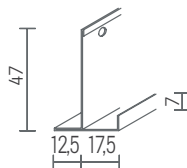

Dikte: 0,6 mm
(voor 15 mm tegels)

Nr. 8034



Kolom ring, twee delen, natuurlijk aluminium, andere kleuren op aanvraag.
Diameter 200 - 1000 mm in 50 mm stappen;
Hoogte 20 mm, breedte 20 mm, dikte 1,5 mm
Opmerking: max. tolerantie kolom diameter +/- 3 mm;
ring in het project aanpassen

Gebogen hoeklijnen

Nr. 50 G

Wandprofiel

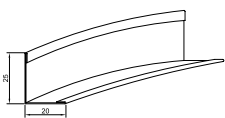

Afmeting: 25/20 mm
Dikte: 1 mm
Zichtzijde: wit

Nr. 51/20

Wandprofiel

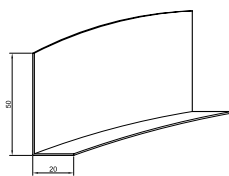

Afmeting: 50/20 mm
Dikte: 1 mm
Zichtzijde: wit

Nr. 50/15 G

Contura wandprofiel

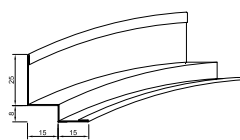

Afmeting: 25/15/8/15 mm
Dikte: 1 mm
Zichtzijde: wit

Nr. 56/20

Stufen wandprofiel

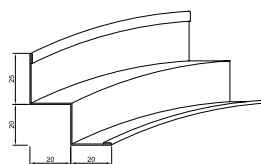

Afmeting: 20/20/20/20 mm
Dikte: 1 mm
Zichtzijde: wit

Nr. 57

Wandprofiel

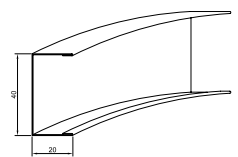

Afmeting: 20/40/20 mm
Dikte: 1 mm
Zichtzijde: wit